



HP102-4

Extinguishant Control Panel

User & Installation Manual



IMPORTANT

This manual should be left with the panel after installation.

We reserve the right to change product specifications without prior notice.

Copyright © Products 2014

INDEX

1. Introduction.....	4
2. Safety.....	5
3. Technical specification.....	6
4. Control Panel Installation.....	7
4.1 Important Notice.....	7
4.2 Mounting.....	7
4.3 AC Power Connection.....	9
4.4 Battery Installation.....	9
4.5 Inner Door Label (Wiring Diagram).....	10
4.6 Connection To Fire Zones.....	11
4.7 Connection To NAC (Sounder) Output Circuits.....	11
4.8 Connection To Relay Contacts.....	12
4.8.1 Fault relay.....	12
4.8.2 Fire relay.....	12
4.8.3 1 st stage alarm.....	12
4.8.4 2 nd stage alarm.....	13
4.8.5 Extract relay.....	13
4.9 Ringing The Alarms Remotely (CC).....	13
4.10 Connection To Remote Control Terminals.....	14
4.11 Connection To Manual Extinguishment Control Buttons.....	15
4.12 Connection To Inhibit Extinguishment Control Buttons.....	15
4.13 Connection To Pressure Switch Input.....	16
4.14 Connection To Pressure Low Switch Input.....	16
4.15 Connection To Auto/Manual Mode Change.....	16
4.16 Connection To Electrovalve Output.....	17
4.17 Connection To Releasing Warning Lamps.....	18
4.18 Connection To Repeater.....	18
4.19 Aux 28VDC Supply.....	19
5. Control Panel Fascia.....	19
6. Panel Operation.....	20
6.1 Normal Condition.....	20
6.2 Single Zone Fire Condition.....	21
6.3 Double Zone Fire Condition.....	21

6.4 Manual Release.....	22
6.5 Evacuate.....	22
6.5 Silence.....	22
6.7 Reset.....	23
6.9 Extract fan.....	23
6.10 Hold On (Inhibit the extinguishant output).....	23
6.11 Zone Fault.....	23
6.12 NAC Circuits Fault.....	24
6.13 Power Fault.....	24
6.14 General Fault.....	24
6.15 Released Condition.....	24
6.16 Low Pressure Switch.....	24
6.17 Change Mode.....	24
7. Access level 3 configuration options.....	25
7.1 Disablements.....	25
7.1.1 Disable Fire Zones.....	25
7.1.2 Disable NAC Circuits.....	25
7.1.3 Disable extinguishant subsystem.....	25
7.1.4 Disable manual release.....	25
7.2 Delay time setting.....	26
8. General Controls.....	27
9. Indications – troubleshooting.....	27
9.1 AC Fault.....	27
9.2 Battery Fault.....	27
9.3 Earth fault.....	27
10. Maintenance.....	28
11. Commissioning instructions.....	28
12. System Log.....	30

1. Introduction

The automatic extinguisher control panel is designed in accordance with European standards EN54-2 and EN54-4 Fire Detection and Fire Alarm systems - Control and Indicating Equipment and EN12094-1 Fixed firefighting systems - Components for gas extinguishing systems - Part 1: Requirements and test methods for electrical automatic control and delay devices.

The control equipment is a combined fire alarm control panel and extinguishing system and has four detection zones, any or all of which are capable of contributing to the extinguishant release decision.

Control panels have an integral, mains powered battery charger and power supply designed in accordance with the requirements of EN54-4.

In addition to the requirements of EN54-2 the control panel has the following facilities:

Test condition to allow the automatic resetting of zones in alarm for testing purposes. EN54-2 Section 10 option with requirements

Delay of the actioning of fire alarm devices (sounders) so that an alarm may be verified before a premises is evacuated. EN54-2 Section 7.11 option with requirements.

Fire alarm devices to enable an audible warning to be sounded throughout premises upon the detection of a fire condition or the operation of a manual call point. EN54-2 Section 7.8 option with requirements

In addition to the requirements of EN54-2, all control panels have voltage free relay contacts for fire and local fire which operate upon a fire condition. These are to be used for local control and signaling.

In addition to the requirements of EN12094-1 the control panel has the following facilities:

Delay of extinguishing signal of up to 75 seconds. EN12094-1 Section 4.17 option with requirements.

Signal representing the flow of extinguishing agent to indicate the released condition. EN12094-1 Section 4.18 option with requirements.

Monitoring of the status of components by way of a low pressure switch input. EN12094-1 Section 4.19 option with requirements.

Emergency hold device to enable the extinguishant delay time to be extended. EN12094-1 Section 4.20 option with requirements.

Control of flooding time to deactivate the releasing output after a set period of time. EN12094-1 Section 4.21 option with requirements.

Manual only mode to disable the release of extinguishant via automatic detection devices. EN12094-1 Section 4.23 option with requirements.

Triggering of equipment outside the system by way of first and second stage contacts, extract fan output etc. EN12094-1 Section 4.26 option with requirements

Activation of alarm devices with different signals to indicate pre-discharge and released warnings using different sounds. EN12094-1 Section 4.30 option with requirements.

2. Safety

Suppliers of articles for use at work are required under section 6 of the Health and Safety at Work act 1974 to ensure as reasonably as is practical that the article will be safe and without risk to health when properly used.

An article is not regarded as properly used if it is used 'without regard to any relevant information or advice' relating to its use made available by the supplier.

This product should be installed, commissioned and maintained by trained service personnel in accordance with the following:

- (i) IEE regulations for electrical equipment in buildings
- (ii) Codes of practice
- (iii) Statutory requirements
- (iv) Any instructions specifically advised by the manufacturer

According to the provisions of the Act you are therefore requested to take such steps as are necessary to ensure that you make any appropriate information about this product available to anyone concerned with its use.

This equipment is designed to operate from 230V/50Hz mains supplies and is of class 1 construction. As such it **must** be connected to a protective earthing conductor in the fixed wiring of the installation and a readily accessible double pole disconnect device meeting the requirements of EN60950/IEC950 which disconnects live and neutral simultaneously shall be incorporated in the fixed wiring. Switch disconnect devices such as MK Sentry 63A or similar are suitable for this.

Failure to ensure that all conductive accessible parts of this equipment are adequately bonded to the protective earth will render the equipment unsafe.

This control panel is environmental class A and is designed for indoor use only at temperatures between -50°C (+/- 3) and $+400^{\circ}\text{C}$ (+/- 2) and with a maximum relative humidity of 95%.

The IP rating for the enclosure is IP30.

Operation outside of these limits may render the equipment unsafe.

3. Technical specification

Table 1 - Electrical specifications

ITEM	ELECTRICAL RATING	COMMENT
Size	383mm W x 295mm H x 87mm D metal enclosure	
Weight	5kg	
Mains supply	90 to 270VAC, 50Hz/60Hz	
Mains supply fuse	3 Amp (F3A L250V)	Replace only with similar type
Power supply rating	3 Amps total including battery charge 28V +/- 2V	
Maximum ripple voltage	≤200 millivolts	
Battery type	Two 12 Volt sealed lead acid in series.	7Ah maximum
Battery charge voltage	27.6VDC nominal	
Battery charge current	0.7A maximum	
Current draw in mains fail condition	0.095 Amps	With buzzer sounding
Current draw in second stage alarm	0.235Amps	Two zones in fire(470 ohm in circuit)
Current draw in post discharge condition	0.310Amps	solenoid outputs active
Maximum current draw from batteries	3Amps	With main power disconnected
NAC outputs(sounder & bell circuit)	26 to 28V DC Fused at 500mA with electronic fuse	1.2Amp total load over all circuits
Fault relay contact rating	2A /30VDC maximum for each	Volt free changeover contact
Fire relay contact rating	2A /30VDC maximum for each	Volt free changeover contact
First stage contact rating	2A /30VDC maximum for each	Volt free changeover contact
Second stage contact rating	2A /30VDC maximum for each	Volt free changeover contact
Extract contact rating	2A /30VDC maximum for each	Volt free changeover contact
Zone quiescent current	4mA maximum	
Terminal capacity	0.5mm ² to 2.5mm ² solid or stranded wire	
Number of detectors per zone	≤30 PCS conventional detectors	
Number of sounders per circuit	Dependent on type and current consumption	
Detection circuit end of line	4K7±5% 1/2 Watt resistor	3K-5.6K 1/2W
Monitored input end of line	4K7±5% 1/2 Watt resistor	3K-5.6K 1/2W
Sounder circuit end of line	10K±5% 1/2 Watt resistor	6.8K-20K 1/2W
Extinguishant output end of line	10K±5% 1/2 Watt resistor	6.8K-20K 1/2W
No. of detection circuits	Four 21 to 28V DC	
No. of sounder circuits	Four 21 to 28V DC	
Extinguishant release output	21V to 28V DC. Maximum load 2 Amp	
Extinguishant release delay time	Adjustable 0 to 75 seconds	5 second steps
SIL, AL, FLT, RST inputs	Switched – min resistance 0 ohms, max 1k ohms	
Detector alarm threshold	270 ohms to 1K ohms	
Call point alarm threshold	150 ohms to 1K ohms	
Short circuit threshold	0 ohms to 130 ohms	
Status unit/Ancillary board connection	Two wire RS485 connection with electronic fuse.	Max. of 32 units-RS485 data cable

4. Control Panel Installation

4.1 Important Notice

This product should be installed, commissioned and maintained by suitably qualified service personnel with reference to IEE regulations and any statutory requirements, for use in fire alarm signaling systems, only when installed in accordance with this manual and the latest National Fire Protection Association Standards NFPA 72; the National Electrical Code (NFPA 70); the Life Safety Code (NFPA 101); and/or the local authority having jurisdiction (AHJ). It is possible to apply system components incorrectly or arrange system components and installation wiring so that required life safety functions are NOT performed. As a result, lives may be lost.

To minimize this possibility:

- ✓ DO NOT deviate from any installation instructions contained in this manual.
- ✓ DO NOT assume any installation details not shown in this manual.
- ✓ DO NOT alter any mechanical or electrical features of the equipment supplied

BE FAMILIAR with the building code, fire prevention code, and/or requirements of the Authority Having Jurisdiction (AHJ) in the locale of the installation.

! Caution !

Under normal and fault conditions, AC line voltages may be present on any terminal. Touching any component could be hazardous and result in loss of life. A short circuit can result in arcing that could cause molten metal injuries to testing personal. To minimize this possibility, only qualified electrical technicians familiar with electrical hazards should perform these checkout procedures. Safety glasses should be worn by such personnel, and instruments used for voltage measurement should be designed for the purpose and should be in good mechanical and working order.

4.2 Mounting

The control panel should be mounted on a dry, flat surface, at eye height to the display and in a level position such that the enclosure is not distorted.

Screws or bolts of a minimum of 6mm diameter must be used to mount the enclosure in all three mounting positions.

It should be positioned in an accessible place as agreed with the end user.

Suitable fixings should be used at all fixing points such that the control panel is securely mounted and is not liable to move once fixed.

The control panel should not be mounted in another enclosure or near sources of excessive heat. Cables should be connected using suitable cable glands fitted to the knockouts provided. If additional cable entry points are required, all swarf and debris

caused by drilling of additional cable entries must be cleared before power is applied to the panel.

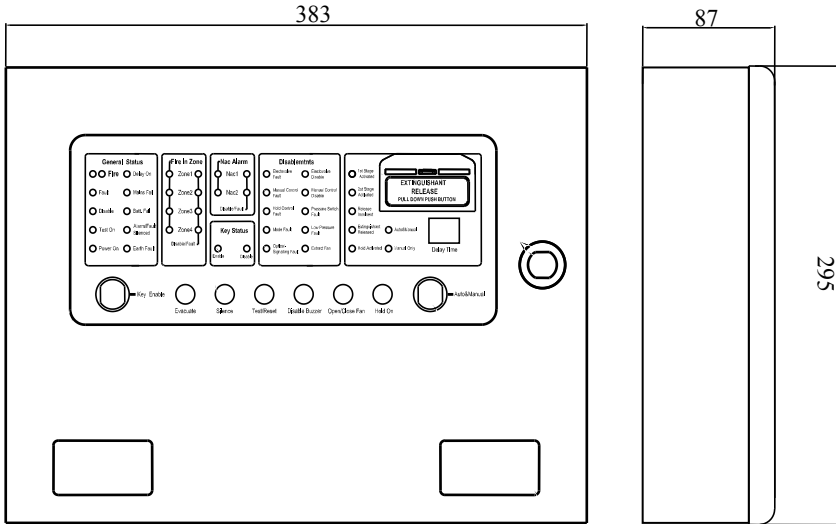
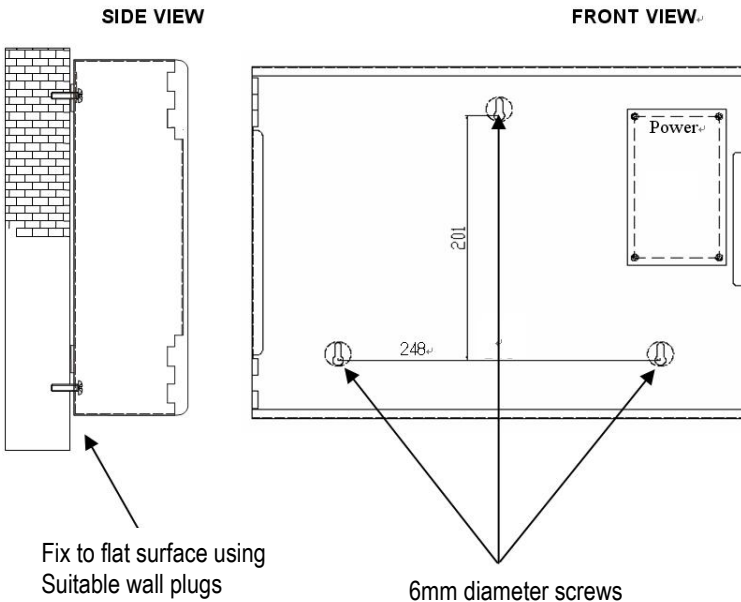

Figure 1. The dimensions of panel



Fix to flat surface using Suitable wall plugs

6mm diameter screws

Figure 2. Mounting

4.3 AC Power Connection

WARNING!

To reduce the risk of electrical shock, make sure that all power has been turned off or disconnected prior to attempting to connect AC power to the Power Supply.

Apply the AC Power BEFORE connecting the batteries to the Panel!

Provide the Control Panel with a dedicated AC Circuit rated 10 Amps or higher. Refer to figure 3 for the AC power wiring diagram.

Enter the power cable into the Cabinet via a knock out hole.

Attach the brown (live) wire from the source to the terminal labeled “L” terminal.

Attach the blue (neutral) wire from the source to the terminal labeled “N” terminal.

Attach the ground wire from the source to the terminal labeled “E” terminal.

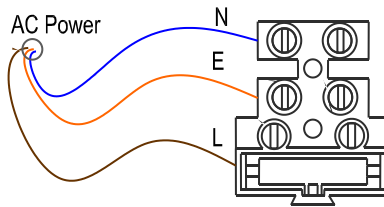

Figure 3 - AC power wiring connection

4.4 Battery Installation

The batteries are placed at the bottom of the enclosure. The panel is fully protected if the batteries are connected in the wrong polarity. The yellow battery fault LED on the display circuit board will show steady in such a condition. When the green battery LED is on steady it shows that the battery condition and connections are normal. See Figure 4 below.

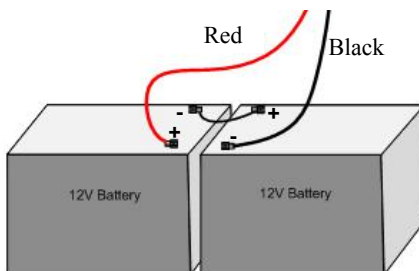

Figure 4 - Batteries wiring connection

4.5 Inner Door Label (Wiring Diagram)

4-ZONES EXTINGUISHER CONTROL PANEL SYSTEM SCHEMATIC

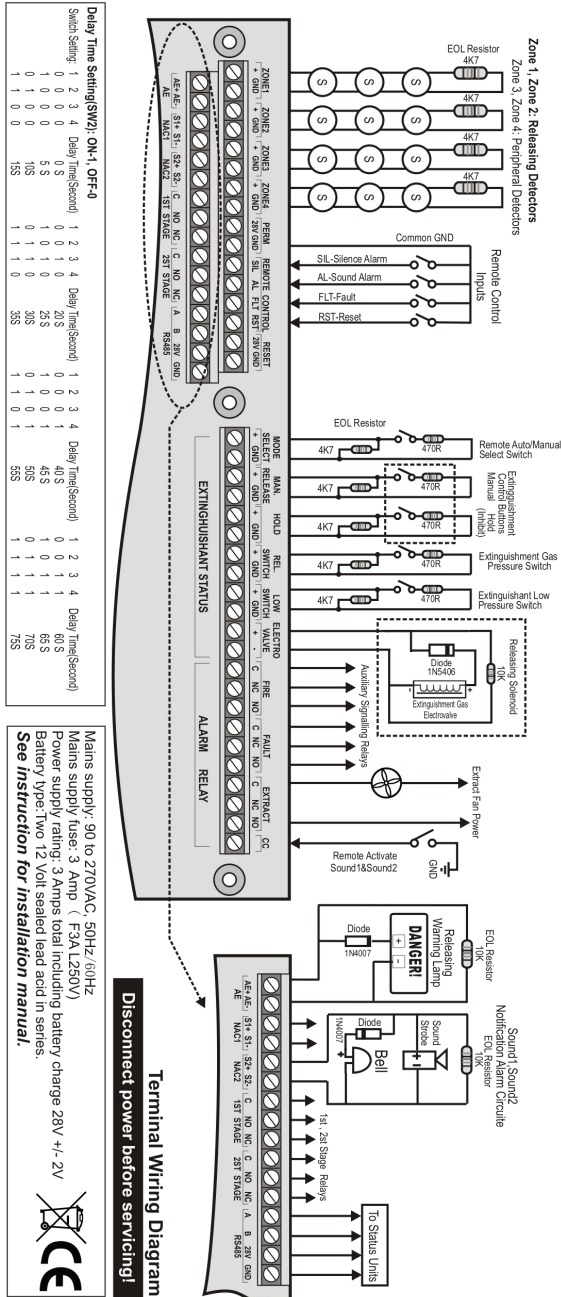

Figure5 wiring diagram

4.6 Connection To Fire Zones

This control panel supports conventional fire detectors (i.e. devices which resemble the operating mode of open contacts during standby status, and resistors during alarm status).

The panel has four fire zones for wire the smoke, heat, multi detectors and call point positive terminals to the terminal labeled “+” and the negative detector terminals to the terminal labeled “-” as shown in figure 6 which shows the panel. Each active zone requires a 4K7 end of line (EOL) resistor at the very end of the zone as shown in figure 6.

Zone1 and zone2 are releasing detectors, zone3 and zone4 are peripheral detectors.

DO NOT connect more than 30 devices to each zone.

The fire zones can be disabled by means of the switch (SW1) which on the main board.

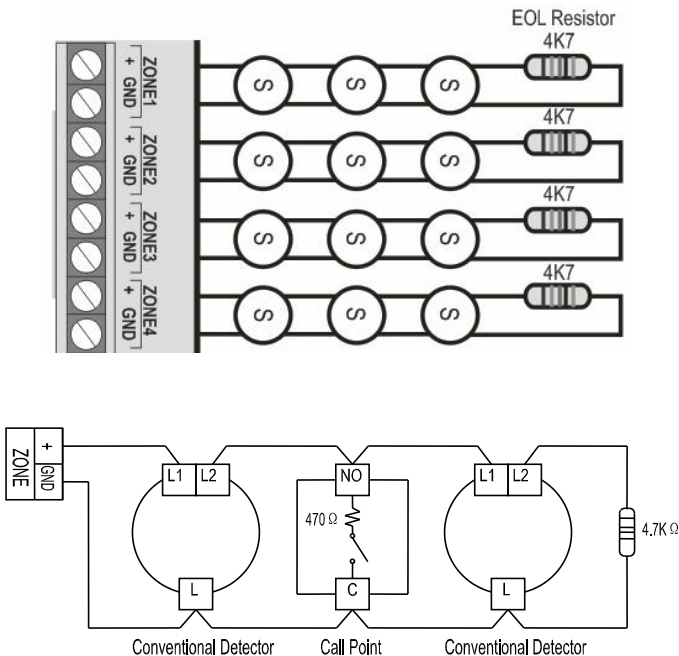

Figure 6 - Detectors wiring connection

4.7 Connection To NAC (Sounder) Output Circuits

NAC1 and NAC2 outputs are for the alarm signalling device connections.

Figure 7 shows output circuit 1 wired as a class B NAC output. Observe the polarity of the wiring and the placement of the 10K end of line (EOL) resistor located at the very end of the class B wiring.

NAC circuits must be wired as a single, radial circuit with no spurs or T junctions to enable the monitoring circuit to work correctly.

A maximum of 1.2 Amps is available for powering sounders with a maximum load of 0.5 Amps on any one circuit.

Connect a 1N4007 diode or similar, between the positive inputs of the devices connected to the S1+ and S2+, and the [+] terminals of the latter.

The NAC circuits can be disabled by means of the switch (SW1) which on the main board.

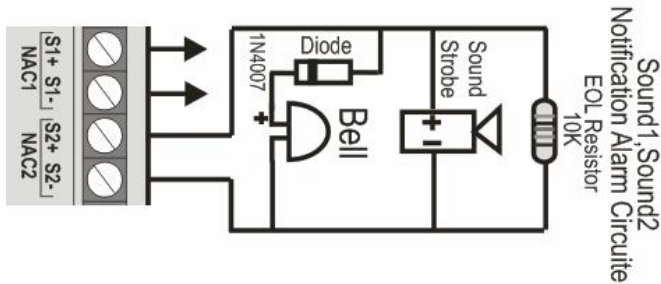

Figure 7 – NACs Wiring Connection

4.8 Connection To Relay Contacts

Volt free changeover relay contacts are provided for local control and signaling if required. These contacts are rated for switching signaling circuits only and the maximum ratings listed in table 1 should not be exceeded under any circumstances. Typically, the relay output of the control panel is switched through these relays and used to control other systems.

4.8.1 Fault relay

The fault relay is normally energised and will de-energise upon any fault condition including total loss of power.

4.8.2 Fire relay

The fire relay will energise upon activation of a fire condition on any of the zones or pressing of the sound alarm button on the front panel. This relay will not operate upon activation of the remote AL input. The relay will remain activated until the panel is reset.

4.8.3 1st stage alarm

The first stage alarm will operate upon activation of a **ZONE1** and **ZONE2** that has been contribute to the extinguishant release decision and will de-activate only when

the panel has been reset. (**ZONE3** and **ZONE4** only for fire alarm that would not contribute to the extinguishant release decision.

This relay will also operate upon activation of the panel mounted or a remote manual release switch.

4.8.4 2nd stage alarm

The second stage alarm relay will operate when the panel enters the activated condition (i.e. the release countdown timer has started) and will de-activate only when the panel has been reset from the released condition.

4.8.5 Extract relay

This provides a means to vent a room of extinguishant gases but prevents the gases from being vented during a discharge.

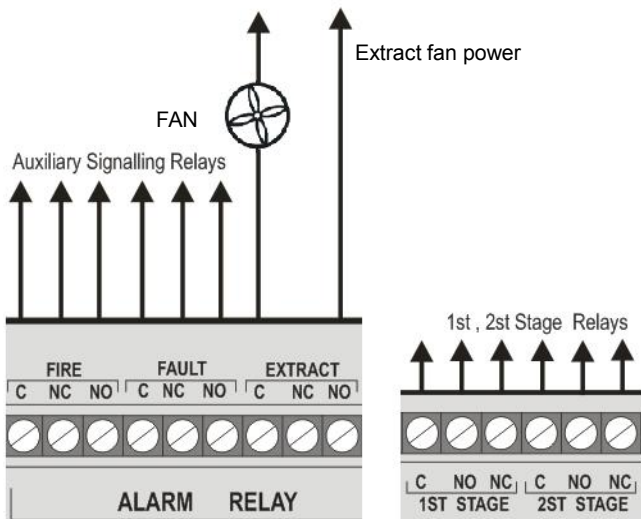

Figure 8 –Connection to relay contacts

4.9 Ringing The Alarms Remotely (CC)

The class change (CC) facility allows a remote source to sound the alarms. When the CC terminal is connected to the 'GND' terminal, the alarms will sound.

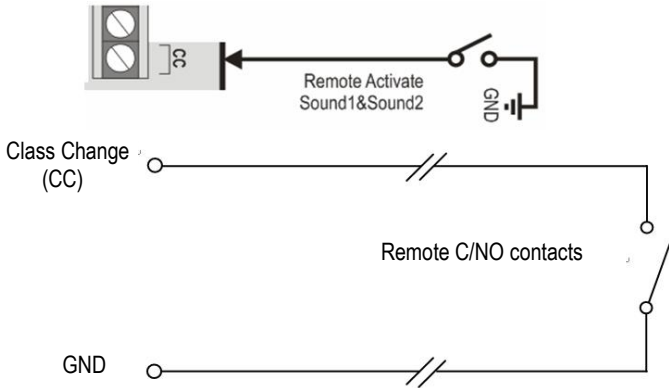

Figure 9 –Ringing the alarms remotely (CC)

4.10 Connection To Remote Control Terminals

Some functions of the control panel can be controlled externally from the panel if required. The external equipment operating inputs must be restricted by an access level 2 control as defined in EN54-2 The functions are abbreviated at the terminals block as follows:

- a) Silence Alarm – SIL (Silences outputs NAC1 &NAC2)
- b) Sound Alarm – AL (Operates outputs NAC1& NAC2 and operates the fire relay)
- c) Fault – FLT (Generates a general fault and operates the fault relay)
- d) Reset – RST (Resets the system back to normal condition)

To activate these inputs, the remote 0 Volt supply must be connected to the input via a normally open switch or contact and via a resistance of no greater than 100 ohms. All of the remote control inputs are non-latching as shown in figure 10.

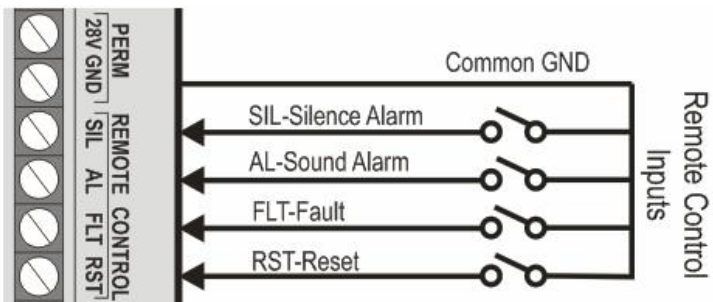

Figure 10 –Connection to remote control terminals

4.11 Connection To Manual Extinguishment Control Buttons

This input is for manual activation of the fire extinguishment systems. Standby status of this input can be either **Normally Open**. Require a 4K7 end of line monitoring resistor and a nominal, 470 ohm trigger resistor.

The manual extinguishment input will activate when inverse conditions to its standby conditions occur. Activation on of the manual extinguishment will start the Pre-Extinguishment Time (delay time, 30 seconds at default).

The manual extinguishment can be disabled by means of the switch (SW1) on the main board.

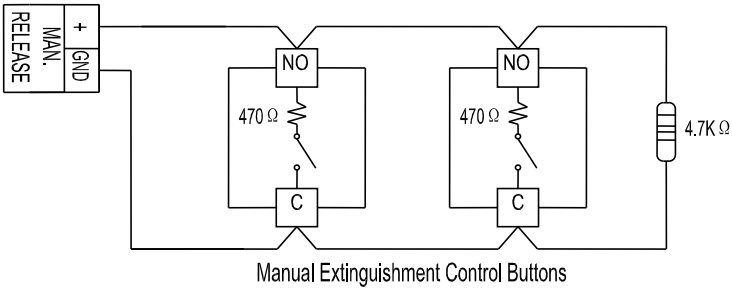

Figure 11 –Connection to manual extinguishment buttons

4.12 Connection To Inhibit Extinguishment Control Buttons

This input is for the inhibition of fire extinguishment systems. The standby status of this input can be either **Normally Open**. Require a 4K7 end of line monitoring resistor and a nominal, 470 ohm trigger resistor.

The inhibit manual extinguishment input will activate when inverse conditions to its standby conditions occur.

If the inhibit manual extinguishment input activates during the Pre-Extinguishment phase, the control panel will STOP Pre-Extinguishment Time.

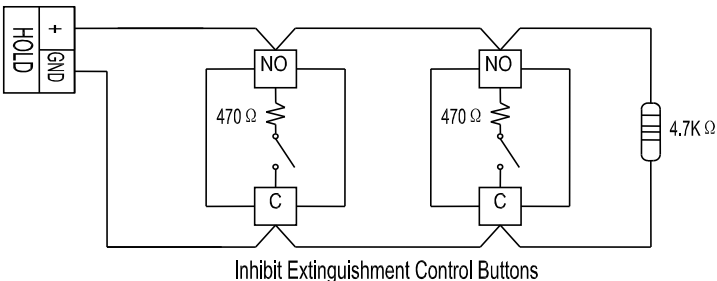

Figure 12 –Connection to inhibit extinguishment buttons

4.13 Connection To Pressure Switch Input

This input is for the pressure switch connection.

Standby status of this input can be either **Normally Open**. Require a 4K7 end of line monitoring resistor and a nominal, 470 ohm trigger resistor.

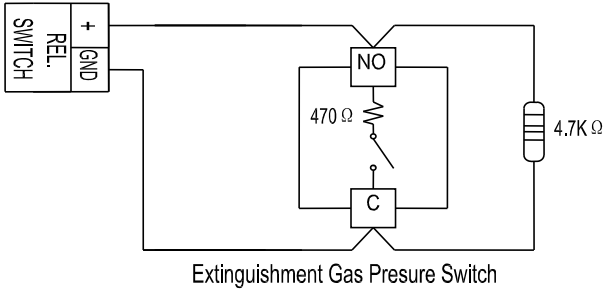

Figure 13 –Connection to pressure switch input

4.14 Connection To Pressure Low Switch Input

This input is for the pressure low (gas leaked) detection connection.

Standby status of this input can be either **Normally Open**. Require a 4K7 end of line monitoring resistor and a nominal, 470 ohm trigger resistor.

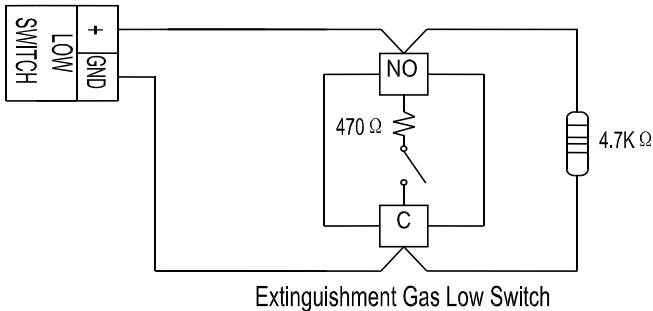

Figure 14 –Connection to pressure low switch input

4.15 Connection To Auto/Manual Mode Change

This input is for the auto control mode change to manual control mode from remote connection.

Standby status of this input can be either **Normally Open**. Require a 4K7 end of line monitoring resistor and a nominal, 470 ohm trigger resistor.

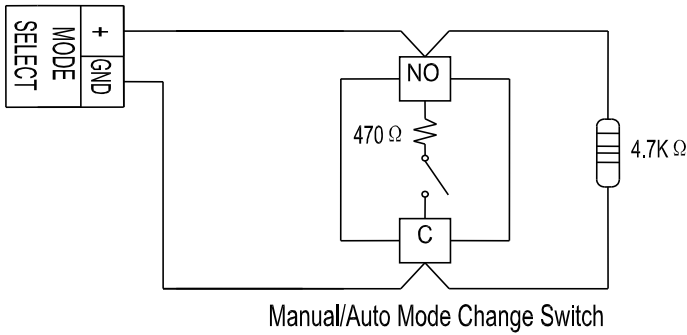

Figure 15 –Connection to mode change input

4.16 Connection To Electrovalve Output

The electrovalve output is capable of supplying up to 1 Amp for the maximum duration to a solenoid or 3 Amps for 20 milliseconds to an igniting actuator and the output can be keep 5 seconds.

The wiring for solenoids and igniting actuators is different as shown below. Igniting actuators of different types or from different manufacturers should not be mixed on the same circuit.

Solenoids must have a resistance of greater than 30 ohms to ensure that the maximum current rating of the extinguishant output is not exceeded.

Connect a 1N5406 diode or similar, between the positive inputs of the devices connected to the Electrovalve+, and the [+] terminals of the latter as show in figure 16.

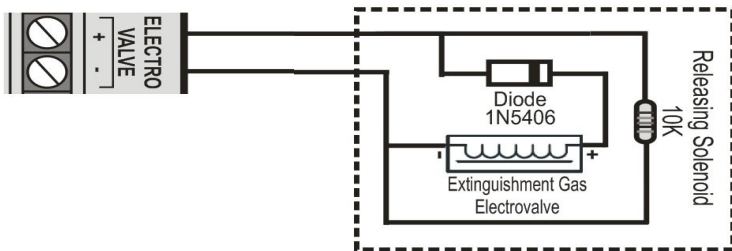

Figure 16 –Example of wiring a solenoid

4.17 Connection To Releasing Warning Lamps

This output is for “Activated Extinguishment” signal.

Observe the polarity of the wiring and the placement of the 10K end of line (EOL) resistor located at the very end of the class B wiring.

Connect a 1N4007 diode or similar, between the positive inputs of the devices connected to the AE+ ,and the [+]terminals of the latter as show in figure 17.

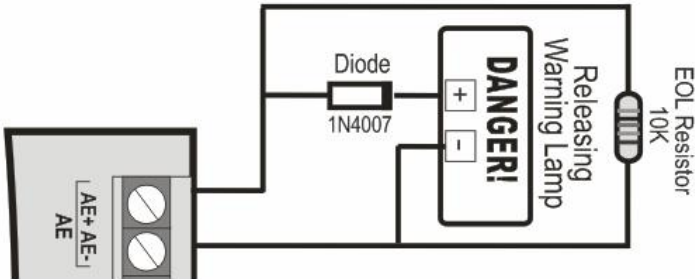

Figure 18 –Connection to release signal

4.18 Connection To Repeater

The control panel should not be powered during the connection of status units or ancillary boards.

Status units and ancillary boards require a four-wire connection from the panel, which drops into each unit and connects to the corresponding data and power, in and out terminals. Two of the cables carry power to the units (24-30VDC) and the other two carry data. A four core cable suitable for carrying RS485 data should be used. If this is a twisted pair cable then one twisted pair should be used for the data connections and the second pair used for the power connections

Each repeater has a 8-bit DIL switch and must be allocated a unique address between 1 and 31. Each ancillary board has a 8-bit DIL switch and must be allocated a unique address between 1 and 31.

The address switch is located on the bottom left hand corner of the status unit or ancillary board PCB. Note: The address is only read when the boards are first powered so address switches should not be altered on a system that has power applied.

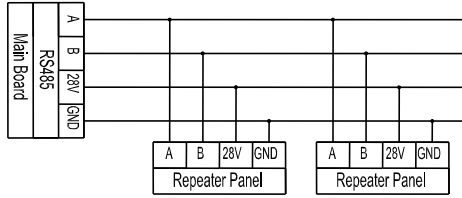

Figure 18 –Connection to repeater

4.19 Aux 28VDC Supply

The control panel provides two 28VDC/1amp supplies that one is a permanent 28VDC output and the other is a resettable 28VDC output.



Figure 19 –Aux 28VDC power supply

5. Control Panel Fascia

In addition to the mandatory controls and indications required by the EN54-2 and EN12094-1 standards, two, seven segment LED displays and Evacuate, Silence, Test/Reset, Disable Buzzer, Extract Fan, Hold On are provided to allow easy operation to the control panel, and Auto & Manual and Manual Only lock switch are provided to allow operated by authorized operator.

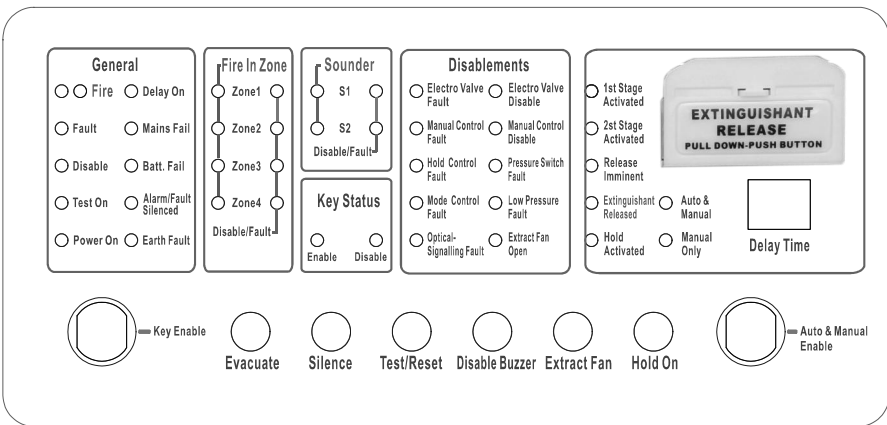

Figure 20- Front panel fascia

The fascia is divided into two sections. A standard EN54-2 control and indicating equipment section with four zones and an EN12094-1 extinguishant system section with extinguishant status and disablements separated for clarity.

The pushbutton controls facilities are common for both sections.

6. Panel Operation

6.1 Normal Condition

Under normal conditions, control panels will have only the green, System On LED lit and either the Manual Only or Automatic and Manual LED lit. The display will be blank.

The control panel has 3 access levels. Access level 1 allows unrestricted access, Access level 2 allows access only after operation of the front panel mounted "Enable controls" key switch and Access level 3 allows access after open the panel and operation of the DIP switch on the main PCB board.

Access level 1: (THE UNABLED STATUS)

Insert the Enable key, **turn to the left**, the panel is switched to the unable status, and then the panel is in the Access level 1, only "Disable Buzzer" button could be operated.

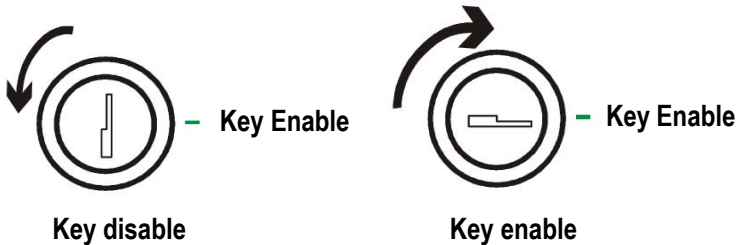

Figure 21- Key status switch

Access level 2: (THE ENABLED STATUS)

Insert the Enable key, **turn to the right**, the panel is switched to the enable status, and then the panel is in the Access level 2, all the buttons could be operated.

Manual Only or Automatic and Manual Mode:

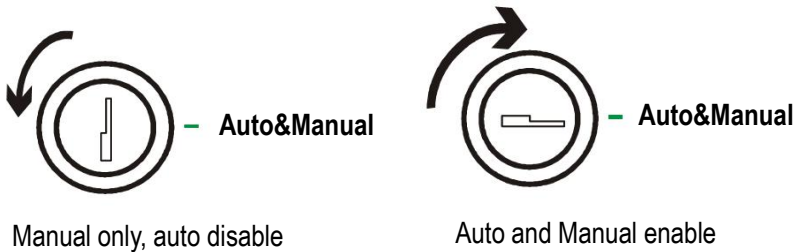

Figure 22- Control mode change switch

6.2 Single Zone Fire Condition

Upon receipt of a fire condition by activation of a detector or call point, the Common Fire indicator will light and the zonal Fire indicators will flash at around 2Hz.

The fire and local fire relays will also operate and signal any systems to which they are connected. Any sounders connected to the NAC circuits NAC1 & NAC2 will operate.

If the zone1 or zone2 that has been activated, the First stage activated LED will light and the first stage relay contact will operate.

6.3 Double Zone Fire Condition

Upon receipt of a second fire condition when the control panel is switched to Automatic and Manual mode, the Hold input is not active, and the Disable Extinguishant Sub-system function has not been invoked, the control equipment will respond as above and as listed below:

- a) The 2nd stage contact will operate.
- b) The Delay LED will blink.
- c) The seven segment LED displays will indicate the time remaining until release in seconds.
- d) The extinguishant output will operate after the configured delay time and for the configured duration after which it shall de-activate.
- e) When the extinguishant outputted, the Release Imminent LED will lit and the Delay LED will turn off.
- f) When the pressure switch operated, the extinguishant released LED will lit and the AE (activated extinguishment) will output.

When detection zones have activated and the activated condition is reached (i.e. the release imminent indicator is lit) it shall not be possible to reset the extinguishant section of the panel until the discharge duration timer has elapsed.

6.4 Manual Release

Upon operation of the front panel mounted manual release button “EXTINGUISHANT RELEASE”, monitored manual release input or a manual release input from a status unit and when the control panel Enable Switch is switched to “**Key Enable**” Status(see the figure21) , the control equipment will respond as above.

To Manual Release the extinguishant output, insert the Enable key, turn to the right then pull down the **EXTINGUISHANT RELEASE** box cover (see the figure 23) , and hold down the button for above 1 seconds. The Delay Timer LED show 10 seconds and then count down the delay time, when the delay time reach 0 seconds, the extinguishant output would be activated.

You can press **HOLD ON** button to pause the delay time.



Figure 23 Extinguishant release box

6.5 Evacuate

The Evacuate button can only be operated at access level 2 (insert the Enable key, **turn to the right to Key Enable status**).

To activate the NAC circuits, press the **Evacuate** button and keep more than 2 seconds.

To cancel evacuate, press **Silence** button.

6.5 Silence

The Silence button can only be operated at access level 2 (insert the Enable key, **turn to the right to Key Enable status**).

To silence the sounders, press the **Silence** button.

When the sounders have been silenced, the zone fire LEDs will change from flashing to a steady state.

6.6 Test Lamp And Buzzer

The Test/Reset button can only be operated at access level 2 (insert the Enable key, **turn to the right to Key Enable status**).

When control panel in normal status (no fault, fire, activate, etc...), to press the Test/Reset button will cause the panel to perform a lamp and buzzer test.

6.7 Reset

The Test/Reset button can only be operated at access level 2 (insert the Enable key, **turn to the right to Key Enable status**).

To reset the panel after a fire/fault/activate event, press the Disable Buzzer button followed by the Test/Reset button.

6.8 Disable Buzzer

To press silence the panel after a fire/fault/activate event, press Disable Buzzer button.

This function is only silenced buzzer of panel.

6.9 Extract fan

The Extract Fan button can only be operated at access level 2 (insert the Enable key, **turn to the right to Key Enable status**).

To extract the fan, press the Extract Fan button.

When the Extract Fan has been activated, the Extract Fan LED will be light.

Pressing the Extract Fan button whilst the extract fan is in this activated conditions, will cause the extract fan to stop again.

The extract fan can be toggled on and off with the Extract Fan button as required.

6.10 Hold On (Inhibit the extinguishant output)

Activation of the hold button pressed or the hold input at the connections inside the panel or at a remotely mounted status unit will cause the Hold Activated indicator to light and the buzzer to sound.

If the control panel is in the 2nd stage alarm condition (i.e. it is in Automatic mode and detection circuits are activated or it is in either Automatic or Manual mode and a manual release input is operated) then the extinguishant release sequence shall be halted and the delay time paused.

6.11 Zone Fault

Removal of a detector from its base or a fault on any of the zone wiring will cause the Fault LED and Zone Fault LEDs to flash, indicating the zone in which the fault has occurred.

6.12 NAC Circuits Fault

A fault on the wiring to NAC circuits (NAC1 and NAC2) will cause the Fault and Sounder Fault LEDs to flash, indicating a fault on the wiring to the NAC circuits.

6.13 Power Fault

Failure of the mains power or disconnection of the standby battery will cause the Fault and Power Fault LEDs to light indicating an abnormality in the power supply to the control panel.

6.14 General Fault

It will illuminate under any fault condition.

6.15 Released Condition

The released pressure switch input is connected to a pressure switch mounted on the extinguishant cylinder which operates when the extinguishant has been released. This will activate the released indicator on the control panel. If the extinguishant has been released by mechanical means i.e. the control panel is not in the activated condition, operation of the released pressure switch input will cause the second stage sounders and second stage relay to operate.

6.16 Low Pressure Switch

The low pressure switch input on the panel is connected to a pressure switch on the extinguishant cylinder which will operate if the pressure in the cylinder falls below a set point. This will happen after the extinguishant has been released but may happen before release through a leak. The flooding zone fault indicator will light and the buzzer will sound when this input is operated.

6.17 Change Mode

The mode of the system can be toggled between **Manual Only** and **Automatic & Manual** by operating the key switch in the extinguishant status area of the panel. When the system is in Manual Only mode, the extinguishant cannot be released by the operation of automatic detectors.

Note: The mode can also be changed to manual by the external mode select input or the key switch on any status unit. Any mode select input to manual mode will override any keyswitches switched to Automatic and Manual mode.

7. Access level 3 configuration options

The control panel has many configuration options which can be set at the time of commissioning to suit the requirements of the installation. These options are normally set once and will rarely need to change. The configuration options are only available at access level 3. To enter access level 3, CAREFULLY open the panel fascia, and two DIP switch can be set

One 8bit DIP switch SW1 is for disablement of zones and some input and output.

7.1 Disablements

It is possible to disable parts of the system. This may be required if there are works going on in a building which may cause the fire alarm system to operate in error.

7.1.1 Disable Fire Zones

To disable zones, the control panel fascia should be removed. There is one 8bit Dip Switch SW1 on the main PCB board. There are four bit to control the four zone disable or not. Set the corresponding switch bit to on to disable the corresponding zone. See the figure 24.

7.1.2 Disable NAC Circuits

The NAC1 and NAC2 output can be disabled. See the figure 24.

7.1.3 Disable extinguishant subsystem

The extinguishant release output can be disabled. See the figure 24.

7.1.4 Disable manual release

The Manual release facility can be disabled . See the figure 24.

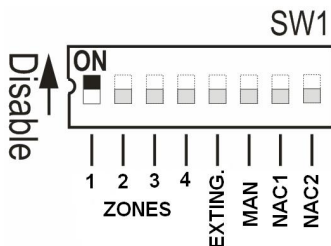

Figure 24 Disablement setting

The Disable LED will light and the Zone Fault LED will light for each disabled zone.

7.2 Delay time setting

Another 4 bit DIP switch SW2 is for delay time setting.

From left to right, it is bit 1 to bit 4 switch. The value is code 8421 from right to left. Each step is five seconds. The delay time setting is as below:

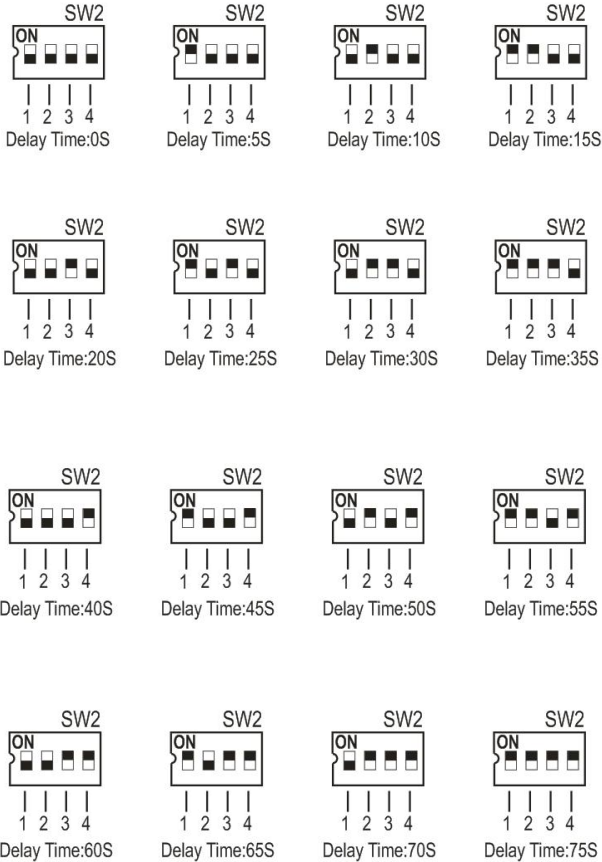

8. General Controls

Once started, the microprocessor controlling the panel should continue to run the panel continuously without interruption. If the microprocessor fails to run correctly it can be reset by pressing the RESET button on the PCB inside the control panel.

This should not normally be necessary but should be done as a matter of course if the system is behaving abnormally. The system should resume normal operation within a couple of seconds of pressing the processor reset button.

9. Indications – troubleshooting

To assist in identifying fault conditions which are not detailed on the front of the control panel, a number of internal indicators are visible with the front cover removed as follows:

9.1 AC Fault

Indicates that the 90V AC -270V AC supply is not present and the system is running on standby batteries.

If there is not a power cut, check the panels mains fuse.

9.2 Battery Fault

Indicate that the standby battery has become disconnected or that the charging circuit of the control panel has failed. Check that both batteries are connected and linked together. Test battery. Disconnect battery and ensure that 28 Volts can be measured on battery charger leads.

9.3 Earth fault

Indicate that part of the system wiring is connected to earth. Remove all system wiring and re- connect cables one at a time until the earth fault returns. This will indicate which cable the earth fault is present on.

10. Maintenance

The control panels do not require any specific maintenance but should the control panel become dirty it can be wiped over with a barely damp cloth. Detergents or solvents should not be used to clean the panel and care must be taken that water does not enter the enclosure.

The control panel contains sealed lead acid batteries to provide standby power in the event of mains failure.

These batteries have a life expectancy of around 4 years. It is recommended that these batteries be tested in accordance with the battery manufacturer's recommendations annually to determine their suitability for continued standby applications.

Testing of the extinguishant system should only be carried out by trained personnel and must be done with appropriate isolation measures in place to ensure that accidental discharge of the extinguishant agent is avoided.

Should the control panel become faulty the complete electronic assembly and front plate can be replaced.

To do this, any configured options should be noted then both mains and battery power should be removed before the work is started.

The field wiring should be carefully labelled and removed from the terminals. The power terminal block can be unplugged from the PCB by pulling it towards you.

11. Commissioning instructions

11.1

Before applying power to the panel, the extinguishant device (solenoid or igniting actuator) must be physically isolated from the system by disconnecting both wires to it. This will prevent any accidental release of extinguishant.

11.2

When power is applied, if all connections are correct, only the green Power On and either the Automatic and Manual or Manual Only indicators should be lit.

If any fault indicators are lit the wiring to the appropriate input or output should be checked and all faults cleared before proceeding.

11.3

Once the panel is fault free, it can be configured with the desired options.

11.4

Once the panel has been configured the system should be thoroughly tested to ensure that the control panel responds as expected and required.

11.5

After satisfactory testing, any final connections should be made (such as to the extinguishant release actuator).

12. System Log

All events should be properly recorded in this log book. An 'event' should include fire alarms (whether real or false), faults, tests, temporary disconnections and the dates of installing or servicing engineer's visits with a brief note of work carried out and outstanding.

Name and address
of installation
.....
.....
.....

Person responsible Date
for log book Date
..... Date
..... Date

System installed by

and is maintained under contract by
Tel.

